

**PLAN**

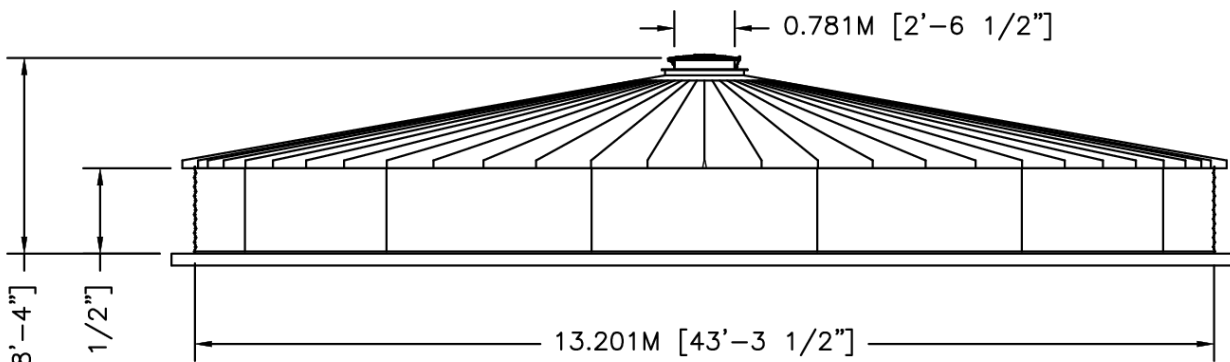

**ELEVATION**



	BY	DATE	TITLE	
DWN	XXX	XX/XX/XX	WTU14-01 30"PR 10DEG V-RIB	
CKD			NOMINAL CAPACITY - 133.841 M3 [35,357 GAL]	
ENG			DWG. NO. SCT4301-LVR WTU14-01	REV. NO.
			SIZE: A	SCALE: 1/8"=1'-0" SHEET 1 OF 1