

8 7 6 5 4 3 2 1

D
C
B
A

D
C
B
A

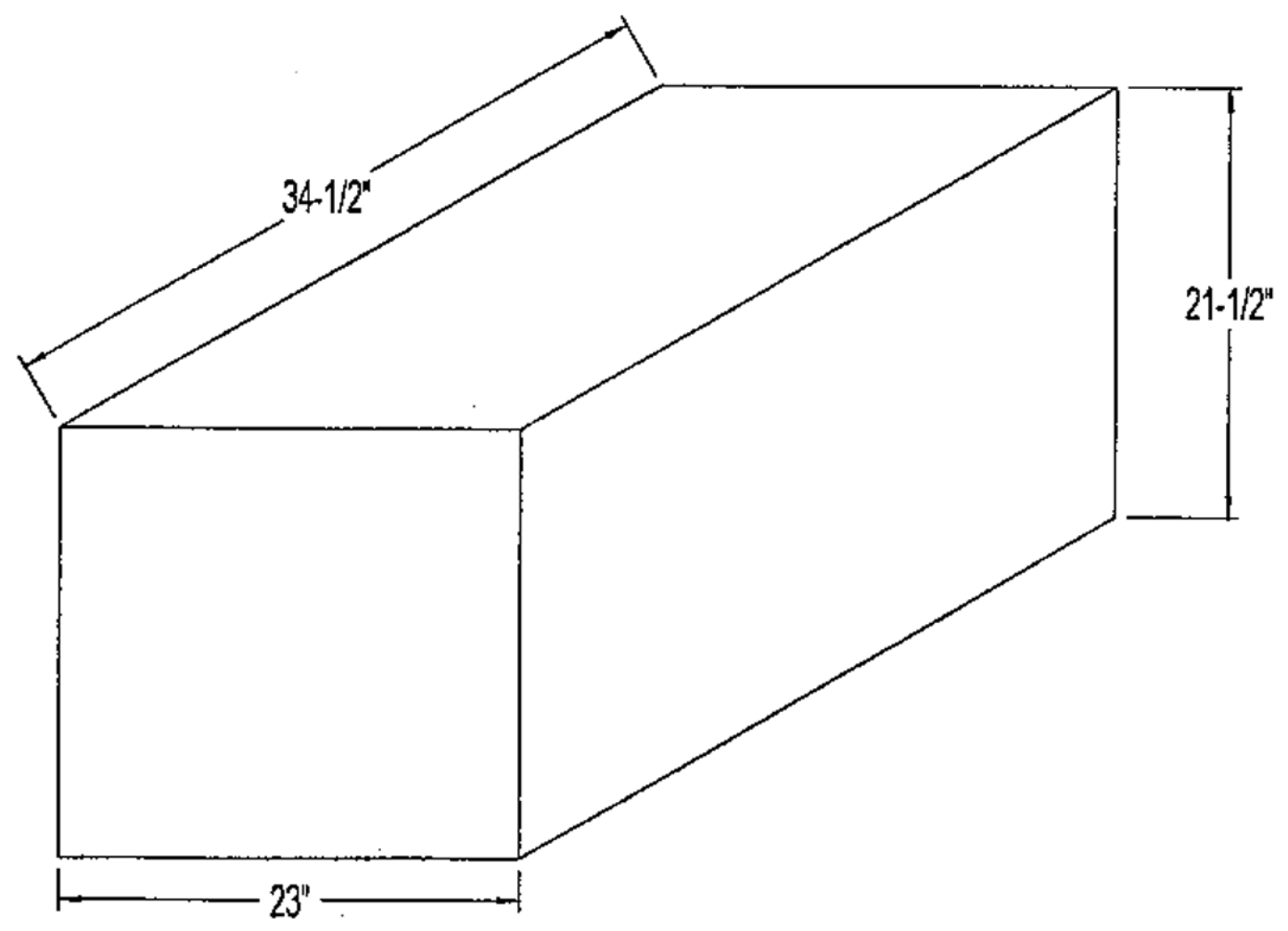

		UNLESS OTHERWISE SPECIFIED:	NAME	DATE	ONE CLARION INC.	
		DIMENSIONS ARE IN INCHES	DRAWN		TITLE:	
		TOLERANCES:	CHECKED		72 GALLON WATER TANK	
		FRACTIONAL ±	ENG APPR.		SIZE DWG. NO. REV	
		ANGULAR: MACH ± BEND ±	MFG APPR.		B W-213	
		TWO PLACE DECIMAL ±	Q.A.		WEIGHT: SHEET 1 OF 1	
		THREE PLACE DECIMAL ±	COMMENTS:			
		INTERPRET GEOMETRIC TOLERANCING PER:				
		MATERIAL				
NEXT ASSY	USED ON	FINISH				
APPLICATION		DO NOT SCALE DRAWING				

8 7 6 5 4 3 2 1